



PULSARLUBE

THE INNOVATIVE LEADER OF AUTOMATIC LUBRICATORS
MASTER CATALOGUE

INDEX

3

Product Portfolio

4

Typical Applications

5

6

Electrochemical Products

Pulsarlube E

Pulsarlube V

7

Mechanical Products

Pulsarlube S

8

14

Electromechanical Products

Pulsarlube M

Pulsarlube M500

Pulsarlube MS

Pulsarlube MSP

Pulsarlube EX

Pulsarlube OL500

Service Packs

15

19

Installation Guides

Pulsarlube Standard Lubricants

Dispensing Recommendations

Installation Options for Pulsarlube Products

Product Portfolio

Products	Models	Lubricant Volume	Dimensions	Available Dispensing Periods	Max.Lube Points	Remote Installation	Operating Pressure	Operating Temp. Range
Electrochemical (Disposable)								
	Pulsarlube E	60cc	Ø77mm (3.03") × 92mm (3.62")	1, 3, 6, 9, 12 months	Single Point	Up to 1m (3ft)	Max.5kgf/cm ² (70psi)	-20°C~55°C (-4°F~131°F)
		120cc	Ø77mm (3.03") × 112mm (4.41")					
		240cc	Ø77mm (3.03") × 157mm (6.18")					
	Pulsarlube V	125cc	Ø97mm(Ø3.81") × 134mm (5.27")	1, 2, 3, 6, 12 months & Purge	Single Point	Up to 1m (3ft)	Max.5kgf/cm ² (70psi)	-20°C~55°C (-4°F~131°F)
		250cc	Ø97mm (Ø3.81") × 152mm (5.98")					
Spring Type (Refillable)								
	Pulsarlube S	100cc	Ø67mm (Ø2.64") × 129mm (5.08")	Five Ascending Steps	Single Point	N/A	N/A	-23°C~121°C (-10°F~250°F)
Electromechanical (Reusable)								
	Pulsarlube M	60cc	Ø91mm (Ø3.58") × 183mm (7.20")	1 ~12 months	8 Points	Up to 6m (20ft) per point	Max.60kgf/cm ² (850psi)	-15°C ~ 60°C (5°F ~ 140°F) -40°C~60°C (-40°F~140°F) with lithium battery pack
		125cc	Ø91mm (Ø3.58") × 183mm (7.20")	Half (H), 1, 2, 3, 6 & 12 months				
		250cc	Ø91mm (Ø3.58") × 210mm (8.26")	Half (H), 1, 2, 3, 6 & 12 months				
		500cc	Ø92mm (Ø3.6") × 260mm (10.2")	Half (H), 1, 2, 4, 6, 12, 18 & 24 months				
	Pulsarlube MS	125cc	Ø91mm (Ø3.58") × 183mm (7.20")	Half (H), 1, 2, 3, 6 & 12 months	8 Points	Up to 6m (20ft) per point	Max.60kgf/cm ² (850psi)	-15°C ~ 60°C (5°F ~ 140°F) -40°C~60°C (-40°F~140°F) with lithium battery pack
		250cc	Ø91mm (Ø3.58") × 210mm (8.26")					
	Pulsarlube MSP	125cc	Ø91mm (Ø3.58") × 183mm (7.20")	Half (H), 1, 2, 3, 6 & 12 months	8 Points	Up to 6m (20ft) per point	Max.60kgf/cm ² (850psi)	-15°C ~ 60°C (5°F ~ 140°F) -40°C~60°C (-40°F~140°F) with lithium battery pack
		250cc	Ø91mm (Ø3.58") × 210mm (8.26")	Half (H), 1, 2, 3, 6 & 12 months				
		500cc	Ø92mm (Ø3.6") × 260mm (10.2")	Half (H), 1, 2, 4, 6, 12, 18 & 24 months				
	Pulsarlube EX	60cc	Ø91mm (Ø3.58") × 183mm (7.20")	1 ~12 months	Single Point	Up to 3m (10ft)	Max.15kgf/cm ² (200psi)	-15°C ~ 60°C (5°F ~ 140°F)
		125cc	Ø91mm (Ø3.58") × 183mm (7.20")	Half (H), 1, 2, 3, 6 & 12 months				
		250cc	Ø91mm (Ø3.58") × 210mm (8.26")	Half (H), 1, 2, 3, 6 & 12 months				
	Pulsarlube OL500	500cc	Ø93.5mm (Ø3.68") × 230mm (9.05")	Half (H), 1, 2, 4, 6, 12, 18 & 24 months	4 Points	Up to 12m (40ft) per point	Avg.10kgf/cm ² (142psi)	-15°C ~ 60°C (5°F ~ 140°F) -40°C~60°C (-40°F~140°F) with lithium battery pack

Typical Applications for Pulsarlube products

Key Industrial Machinery

- Electric Motors
- Pumps
- Conveyors
- Blowers
- Air Makeup Units
- Fans
- Air Conditioners
- Agitators
- Cranes / Hoists / Loaders / Stackers
- Escalators / Elevators / Lifts
- Furnaces & Ovens
- Cable Ways

Industries

- Iron / Steelmaking
- Automotive
- Mining (Open Pit / Underground)
- Cement
- Petrochemical
- Oil Refinery
- Pulp / Paper
- Electronic / Semiconductor / LCD
- Brewery
- Marine
- Food / Beverage
- Other Heavy Industry

Non-manufacturing

- Airports
- Metros
- Hotels / Resorts
- Skyscrapers
- Shopping Malls
- City Water Treatment Facilities
- Waste Water Treatment Facilities
- Sewage Treatment Facilities
- Shipyards
- Bridges



Pulsarlube E

Automatic Lubricators



Overview

The Pulsarlube E is designed to offer superior advantages in cost competitiveness and user friendliness over conventional gas type single point lubricators (SPL). The Pulsarlube E has a creative and innovative design which satisfies a wide variety of demands for industrial applications. It operates based on the proven technology of electrochemical reaction which generates inert Nitrogen (N₂) gas through the systematic use of an electrolyte and electrical energy.

The Pulsarlube E utilizes an intuitive mode selecting mechanism to ensure an error-free and simple operation. The Pulsarlube E is the right choice for a cost effective, reliable, and safe SPL product for most industrial applications.

Specifications

Features	Specifications
Gas Type	Nitrogen (N ₂) gas
Gas Generating Method	Electrochemical
Grease Capacity	60cc, 120cc, 240cc
Housing Design	Transparent plastic
Operating Temp Range	-20°C~55°C (-4°F~131°F)
Operating Pressure	Max. 5kgf/cm ² (70psi)
Remote Installation	Up to 1m (3ft) using a 8mm (5/16") O.D. tube
Available Dispensing Periods	1, 3, 6, 9 & 12 months
Product Size	60cc : Ø77mm (3.03") × 92mm (3.62") 120cc: Ø77mm (3.03") × 112mm (4.41") 240cc: Ø77mm (3.03") × 157mm (6.18")
Certifications / IP code	ATEX / CE / UL / IP68
Packaging	10 Units/Case

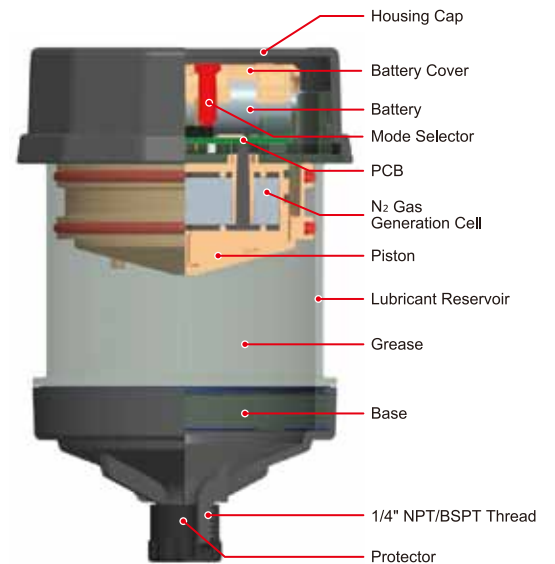

Dispensing Period Selection

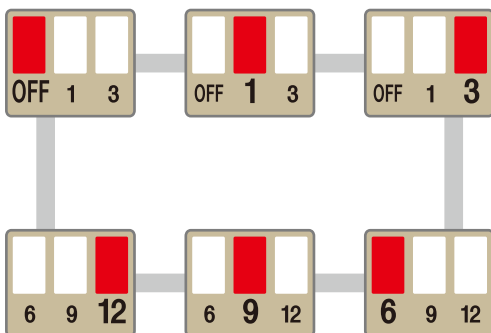

Benefits

- Highly cost effective
- Available in three sizes (60, 120, 240cc)
- Easy to install and simple to operate
- Five available dispensing periods from 1 to 12 months
- Convenient for use in confined spaces
- Durable and reliable engineering
- Transparent container for easy visual inspection of lubricant levels
- Resilient 1/4" NPT/BSPT compatible output thread

How to order



E60 / PL1 (60cc)
E120 / PL1 (120cc)
E240 / PL1 (240cc)

① ②

- ① Pulsarlube Model #
- ② Grease Type

Pulsarlube V

Automatic Lubricators



Overview

The Pulsarlube V's pro-logic microprocessor chip control allows for programming of the unit to be as simple as pressing a single button. The Pulsarlube V operates on the principle of inert Nitrogen (N₂) gas generation through the use of an electrolyte and electrical energy. Pressure is generated intermittently above the piston which delivers a fresh and precise amount of lubricant to your critical rotating equipment. The Pulsarlube V is also certified for "intrinsic safety" Ex ia IIC T4 for use in hazardous areas.

Specifications

Features	Specifications
Gas Type	Nitrogen (N ₂) gas
Gas Generating Method	Electrochemical
Housing Design	Transparent plastic
Capacity	125cc, 250cc
Remote Installation Distance	Max. 1m (3ft) with 8mm (5/16") O.D. tube
Operating Indicator	"OPER" blinks on LCD
Available Dispensing Periods	1, 2, 3, 6, 12 months & Purge (P)
Operating Pressure	Max. 5kgf/cm ² (70psi)
Operating Temperature Range	-20°C~55°C (-4°F~131°F)
Rating / IP code	Ex ia IIC T4 / IP68
Packaging	10 Units/Case

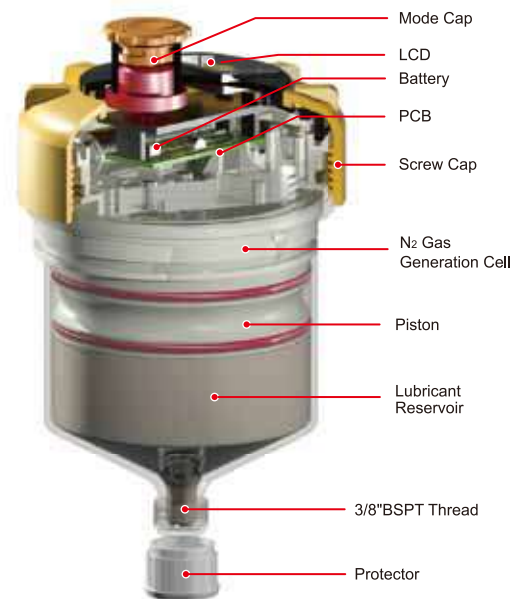

LCD Display

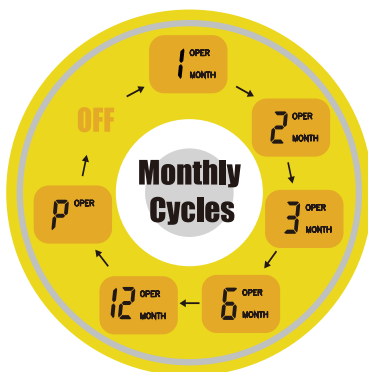

Benefits

- Variable settings available with the press of a button
- Large user friendly LCD display
- Microprocessor controlled to ensure the most accurate dispensing rate
- Reprogrammable at any time if necessary
- More reliable against ambient temperature variations than hydrogen gas type lubricators
- Transparent container for easy visual inspection

How to order



V125 / PL1 (125cc)

V250 / PL1 (250cc)

- ① ②

- ① Pulsarlube Model #
② Grease Type

• Note : Use the waterproof cap provided for added protection.

Pulsarlube S

Automatic Lubricators



Overview

The innovative Pulsarlube S has a very unique and scientific design which has solved many issues that have plagued spring type lubricators for decades. The Pulsarlube S possesses an ingenious new design that contains a spring at the bottom, which in turn pushes the lubricant upward into the lubricator's grease intake orifice, then down a guide sleeve and into the lubrication point.

This new paradigm dramatically diminishes the problem of oil separation because it is pushing up, not down. The upward piston movement prevents the possibility of oil from dripping out due to the effect of gravity and maintains the lubricant as a whole within the chamber, thereby preventing hardening of the grease and allowing the lubricator to completely empty out its contents.

Specifications

Features	Specifications
Capacity	100cc
Operating Temperature Range	-23°C~121°C (-10°F~250°F)
Installation Thread Size	1/4" NPT & BSPT compatible resilient composite plastic
Dimensions	Ø67mm (2.64") x 129mm (5.08")
Packaging	10 Units/Case

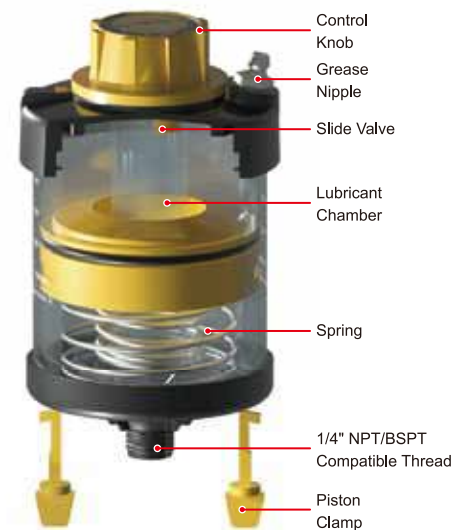

Dial Display



Benefits

- Dramatically reduces oil separation while in storage due to its strategically placed piston clamps
- Available pre-filled and can be installed right out of the box
- Much more reliable and effective than any other conventional spring type lubricator due to upwards piston movement
- Contains a variety of dispensing rates to suit all applications
- User friendly
- Refillable on-site

How to order



S100 / PL1 (100cc)

① ②

- ① Pulsarlube Model #
- ② Grease Type

Caution



- Do not install the Pulsarlube S on open/unshielded bearings.
- Overfilling of grease may cause damage to the lubricator. When filling, the piston should not be allowed to go below the line marked "Do not fill below this line".
- Only use a manual grease gun to refill the Pulsarlube S.

Pulsarlube M

Automatic Lubricators



Overview

The innovative Pulsarlube M is designed to ensure reliable lubrication and at the same time cut lubrication costs with an advanced computerized control system. It consists of a vertical feed pump, motor/gear set, and microprocessor allowing operating pressure of 30kgf/cm² (425psi). It is ideal for hard to reach/hazardous locations via its remote installation capability.

Specifications

Features	Specifications
Capacity	60cc, 125cc, 250cc
Pump Type	Vertical self priming pump
Available Dispensing Periods	60cc: 1 ~ 12 months
	125, 250cc: Half (H), 1, 2, 3, 6 & 12 months
Operating Pressure	Avg. 30kgf/cm ² (425psi) Max. 60kgf/cm ² (850psi)
Operating Temperature Range	-15°C ~ 60°C (5°F ~ 140°F) -40°C ~ 60°C (-40°F ~ 140°F) with a lithium battery pack
Battery	DC 4.5V battery pack (replaceable)
Installation Thread Size	3/8" PT
Dispensing Volume	0.34cc/piston stroke @ 20°C
IP Code	IP54
Multi Point Lubrication	Can lubricate up to 8 points, 6m (20ft) per point
Product Certifications	CE
Packaging	10 Units/Case

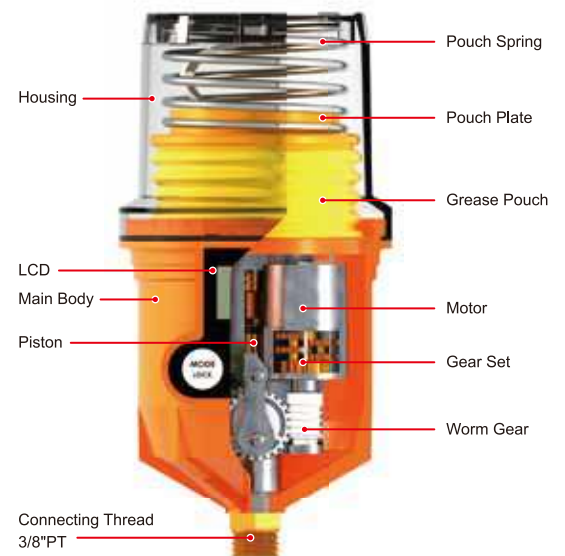

LCD Display

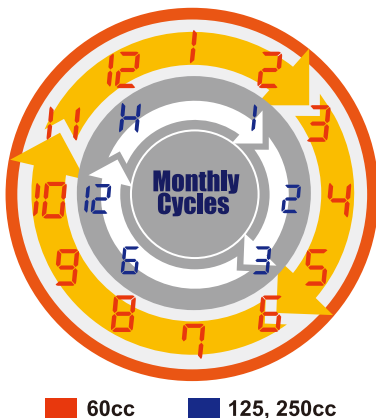

Benefits

- Built-in large LCD makes it easy to read and provides all necessary information to optimally monitor your equipment. Easy-to-decipher indicators on LCD assist you in understanding the condition of your lubricator and lube point at a glance
- User friendly programming is simple with the press of a single button
- Environmentally friendly, Pulsarlube M is reusable!
- High operating pressure permits you to conveniently lubricate hazardous and hard to reach areas
- Variable settings
60cc- 1 to 12months
125/250cc- 6 optional dispensing periods from 1, 2, 3, 6, 12 and half month
- The Pulsarlube M's innovative, well balanced design and possession of a tempered steel shaft with a brass finish tip allows the M unit to excel in high vibration applications
- A microprocessor chip accompanied along with a powerful positive displacement pump enables the Pulsarlube M to effortlessly dispense an exact amount of fresh lubricant at precisely programmed intervals

How to order



M125 / PL1 (125cc)

M250 / PL1 (250cc)

①

②

① Pulsarlube Model #

② Grease Type

Pulsarlube M500

Automatic Lubricators



Overview

The Pulsarlube M500 is primarily designed to meet the requirements of larger bearings (over 102mm, 4" O.D.) commonly found in mining, cement, and steel industries. It offers a large 500cc volume capacity as well as 8 different dispensing periods up to 24 months.

With the ability to operate at high working pressures, the Pulsarlube M500 can be remotely installed to lubricate up to 8 points, 6m (20ft) per line with the use of a lithium battery pack. The Pulsarlube M500 is the right choice to ensure reliable lubrication of larger bearings.

Specifications

Features	Specifications
Capacity	500cc (replaceable grease pack)
Pump Type	Vertical self-priming pump
Available Dispensing Periods	Half(H), 1, 2, 4, 6, 12, 18 & 24 months
Operating Pressure	Avg. 30kgf/cm ² (425psi) Max. 60kgf/cm ² (850psi)
Operating Temperature Range	-15°C~60°C (5°F~140°F) -40°C~60°C (-40°F~140°F) with a lithium battery pack
Battery	DC 4.5V battery pack (replaceable)
Multi Point Lubrication	Can lubricate up to 8 points, 6m (20ft) per point
Packaging	10 Units/Case

Features of the Pulsarlube M500

- Large 500cc grease volume
- Wide operating temperature range
- Unrivaled operating pressure
- 8 different dispensing options from Half to 24 months in a single unit
- Easy to replace grease and battery pack

NOTE

Battery pack type needed may vary depending upon type of application. Refer to the Battery Selection Guide below.

LCD Display

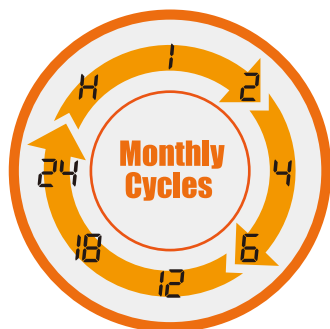

Battery Selection Guide

Application	Alkaline Battery Pack	Lithium Battery Pack
Multi Point Lubrication	N/A	Up to 8 points
Remote Installation	3m (10ft) or less on a single line	Up to 6m (20ft) per line
Operating Temp Range	-15°C ~ 60°C (5°F~140°F)	-40°C ~ 60°C (-40°F~140°F)
Programing	Up to 12 months	Up to 24 months

How to order



M500 / PL1 (500cc)

M501 / PL1 (500cc)

① ②

① Pulsarlube Model #

(M500: with Alkaline Battery, M501: with Lithium Battery)

② Grease Type



Overview

The Pulsarlube MS is engineered to operate in synchronization with the equipment on which it is installed. The Pulsarlube MS unit will dispense the preset amount of grease as long as the machine is operating.

If the equipment is not on, the Pulsarlube MS unit goes into "stand-by mode" and does not dispense lubricant until the machine goes back into operation. The Pulsarlube MS can prevent any waste of lubricant as well as damage or loss to your equipment resulting from over-lubrication.

Specifications

Features	Specifications
Capacity	60cc, 125cc, 250cc
Operating Pressure	Avg. 30kgf/cm ² (425psi) Max. 60kgf/cm ² (850psi)
Operating Temperature Range	-15°C~60°C (5°F~140°F) -40°C~60°C (-40°F~140°F) with a lithium battery pack
Battery	DC 4.5V battery pack (replaceable)
Multi Point Lubrication	Can lubricate up to 8 points, 6m (20ft) per point
Packaging	4 Units/Case (includes Relay Box)



LCD Display

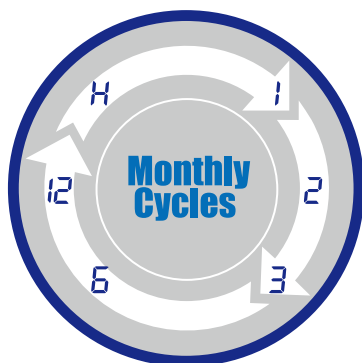

Specifications for Relay Box

Features		Specifications
Voltage Rate Input Range		AC 100~480V, 0.5W/50~60Hz
Voltage Rate Output Range		Signal (Open collector type)
Power ON Indicator		Red LED will display
Relay Box Dimensions		85mm (L) x 49mm (W) x 32mm (H)
Wire length	From Power supply	Input: 1m Output: 4.5m
	From MS Lubricator	90mm

How to order



MS125 - VAC / PL1 (125cc)

MS250 - VAC / PL1 (250cc)

① ② ③

- ① Pulsarlube Model #
- ② Relay Box
- ③ Grease Type

• Note : The battery pack must be replaced along with the grease pouch to ensure reliable lubrication.

Pulsarlube MSP

Automatic Lubricators



Overview

The Pulsarlube MSP unit offers the advantage of providing automatic lubrication to machinery that is infrequently or intermittently used by synchronizing itself to the equipment, thereby avoiding the problem of over lubrication.

The Pulsarlube MSP will dispense a preset amount of grease as long as the machine is operating and does not dispense lubricant if the equipment stops. The unit goes into "stand-by mode" until the machine goes back into operation. The Pulsarlube MSP can be externally powered by the machine or the PLC. There is no need to replace the battery pack in the MSP for up to 5 years.

Specifications

Features	Specifications
Capacity	60cc, 125cc, 250cc, 500cc
Operating Pressure	Avg. 30kgf/cm ² (425psi) Max. 60kgf/cm ² (850psi)
Operating Temperature Range	-15°C~60°C (5°F~140°F) -40°C~60°C (-40°F~140°F) with a lithium battery pack
Battery	DC 4.5V battery pack (Avg. service life: 5 years)
Multi Point Lubrication	Can lubricate up to 8 points, 6m (20ft) per point
Packaging	4 Units/Case (includes Power Supply)



LCD Display

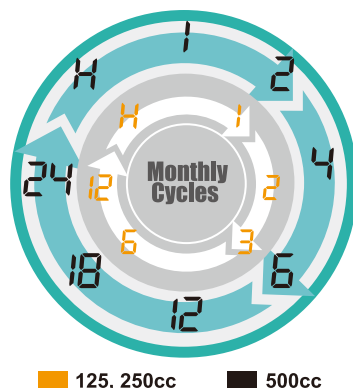

Specifications for MSP Power Supply

Features		MSP VAC AC-DC Adapter	MSP VDC DC-DC Converter
Voltage Rate Input Range		100 ~ 220V, 0.5A 50 ~ 60 Hz	12V ~ 24V
Voltage Rate Output Range		5.0V, 2A	
Power ON Indicator		Red LED	
Power Supply Dimensions		85mm(L) x 49mm(W) x 32mm(H)	
Wire Length	From Power Supply	Input	1m
		Output	4.5m
		From MSP Lubricator	90mm

How to order



MSP125 - VDC / PL1 (125cc)

MSP250 - VAC / PL1 (250cc)

① ② ③

① Pulsarlube Model #

② Power Supply Type

③ Grease Type



Overview

The Pulsarlube EX is a Class I, Division 2, Group C, D certified, battery operated, single point lubricator with a powerful positive displacement pump engineered to reliably lubricate your equipment.

The Pulsarlube EX is specially designed with a modified enclosure rated for limited hazardous locations Class I, Div. II, Sec. C, D.

Specifications

Features	Specifications
Capacity	60cc, 125cc, 250cc
Available Dispensing Periods	60cc: 1 ~ 12 months
	125, 250cc: Half (H), 1, 2, 3, 6 & 12 months
Operating Pressure	Max. 15kgf/cm ² (200psi)
Operating Temperature Range	-15°C~60°C (5°F~140°F)
Battery	DC 4.5V battery pack (replaceable)
Installation Thread Size	3/8" PT
Remote Installation Distance	Max. 3m (10ft) with a single 6mm (1/4") line
Packaging	10 Units/Case

Description of Certifications

Certification	UL	ATEX	KTL
Rating	Class I Division 2 Groups – C, D	EEX nL IIB T5 IP54	EEX nL IIB T5 IP54
Gas groups	D-C1 I Div 1/2	IIA	IIA
	D-C1 I Div 1/2	IIB	IIB
Maximum Surface Temp	T6(85°C)	T5(100°C)	T5(100°C)
Enclosure protection indices	-	IP54	IP54
Classification of hazardous locations	C1 I Div2 C1 I Zone2 (gas)	Zone2 (gas) Zone22 (dust)	-
Certification File#	E304815	LCIE 07 ATEX 6100X	12-KB2BO-0279X

UL Certification for Hazardous Areas

The Pulsarlube EX has been tested by UL labs and meets the following requirements: UL79, Power-operated pumps for petroleum-dispensing products, ANSI/ISA 12.12.01-2000 (8th edition), Non-incendive electrical equipment for use in Class I, Div. 2, Group C, D.

Rating	Certification Description
CLASS I	Flammable gases, vapors, or liquids
DIVISION 2	Where ignitable concentrations of flammable gases, vapors, and liquids are not likely to exist under normal operating conditions
GROUPS - C, D	C (Ethylene), D (Propane)

How to order



EX60 / PL1 (60cc)
 EX125 / PL1 (125cc)
 EX250 / PL1 (250cc)

① ②

① Pulsarlube Model #
 ② Grease Type

Caution



- Always use a Pulsarlube OEM standard alkaline battery pack.
- Power off the lubricator before accessing the battery pack for any reason.

Pulsarlube OL500

Automatic Lubricators



Overview

The Pulsarlube OL500 is our latest innovation in oil lubrication specifically designed to deliver a fresh, consistent, and precise amount of oil to all of the vital parts of your rotating equipment.

The precise and reliable lubrication of the Pulsarlube OL500 significantly reduces wear, oil consumption, and also extends the service life of your machinery; thus cutting high maintenance costs dramatically. The OL500 is easily refillable.

Specifications

Features	Specifications
Capacity	500cc
Available Dispensing Periods	Half (H), 1, 2, 4, 6, 12, 18 & 24 months
Operating Pressure	Avg. 10kgf/cm ² (145psi) depending on oil viscosity
Operating Temperature Range	-15°C~60°C (5°F~140°F) -40°C~60°C (-40°F~140°F) with a lithium battery pack
Oil Viscosity Range	Max. 10,000 cSt @ 40°C
Battery	DC 4.5V battery pack (replaceable)
Multi Point Lubrication	Up to 4 points using remote installation kit
Packaging	10 Units/Case



LCD Display

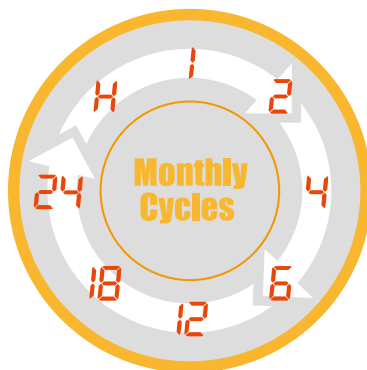

OL500 Installation Kits

Item #	Description
1250RO-1	1 point remote installation kit for Pulsarlube OL500
1250RO-2	2 point remote installation kit for Pulsarlube OL500
1250RO-3	3 point remote installation kit for Pulsarlube OL500
1250RO-4	4 point remote installation kit for Pulsarlube OL500
C030 C031 C032 C033	Oil Brush & Bracket Kit for Pulsarlube OL500

• Note: Oil brush not included in the 1250RO kits

How to order



OL500 / EMPTY (500cc)
①

① Pulsarlube Model #

Caution



- Turn the black hand knob on top of the lubricator's housing counterclockwise 2 to 3 times to open the vent.
- Avoid running the OL500 on empty to prevent possible air jam/air lock.

Note: The Pulsarlube OL500 is supplied empty by manufacturer. Please contact local distributor for other options.

Service Packs for Electromechanical Lubricators

The Pulsarlube electromechanical grease lubricators are developed to last multiple cycles through the use of replaceable service packs. As a result, one of the most significant benefits of the Pulsarlube electromechanical lubricators is the substantial accumulated savings over the cost of manual lubrication while providing assurance of the most precise and reliable lubrication quality.

Replaceable Service Pack consists of :

- A grease pouch of selectable lubricant type and volume of 60, 125, 250, or 500cc
- An OEM battery pack :
 - Standard DC 4.5V Alkaline
 - Optional DC 4.5V Lithium
- A disposable dust cover

⚠ WARNING

The grease pouch and battery pack **must always be replaced together** at the end of each lubrication cycle to ensure reliable operation and guaranteed performance of the lubricator.

NOTE Keep Service Pack stored in a cool and dark place.



Service Pack Installation

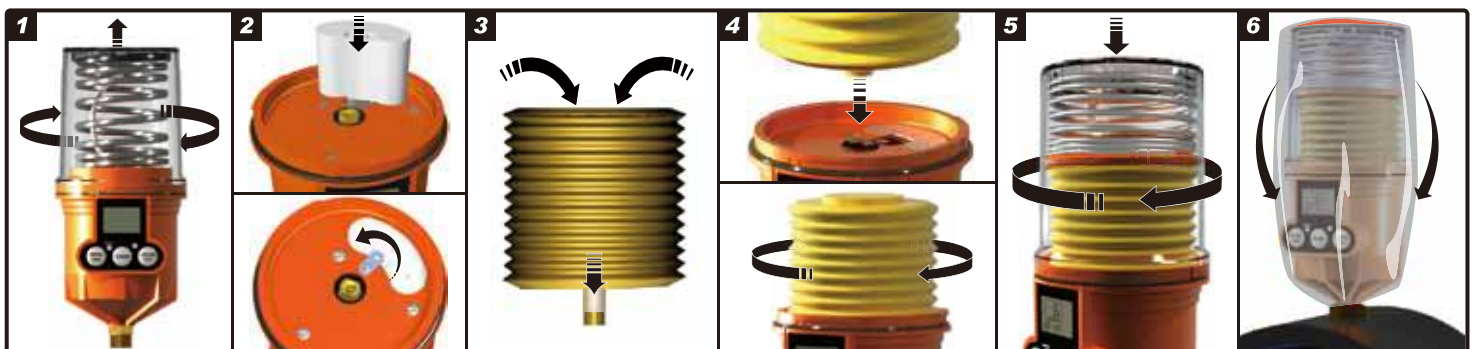

Pulsarlube Standard Lubricants

Refer to following information of available lubricants carefully selected for Pulsarlube products. Please choose the proper lubricant for your specific application. If further information is required, please contact your local supplier or manufacturer.

Grease Code	Application	Thickener	Base Oil	Description
PL1	Multi Purpose	Lithium Complex	Mineral	High performance NLGI 2 grade
PL2	Heavy Duty	Lithium & Lithium Complex	Mineral	Excellent heavy duty NLGI 2 grade with high viscosity base fluids and additional load carrying capacity
PL3	High Speed	Lithium	Mineral	High performance NLGI 1 grade for high speed applications (over 3,000 rpm or high DN value)
PL4	H1 Food Grade	Aluminum Complex	Mineral	USDA H1 NLGI 2 grade for applications where a food grade product is required
PL5	High Temperature	Lithium Complex	Fully Synthetic	Fully synthetic high performance NLGI 2 grade with oxidation stability for high temperature use
PL6	Multi Purpose with MoS2	Lithium Complex	Mineral	High performance grade with MoS2 for better EP and load carrying capacity
PL7	Low Temperature	Lithium & Lithium Complex	Fully Synthetic	Fully synthetic NLGI 1 grade, for extreme low temperature applications

NOTE OEM filling is available upon request under special terms and conditions. Please contact your local distributor or manufacturer.

Grease Compatibility

Not all grease products are compatible.

Grease consists of two parts-the actual lubricant (normally base oil) and a carrier (thickener).

Different types of thickeners may not be compatible to one another. Mixing incompatible grease can cause catastrophic damage to equipment. It is very important to identify the thickener of the grease perviously used and to check its compatibility with the grease contained in the Pulsarlube product. Please use the chart below as a guideline to determine grease compatibility. If further information is required regarding grease compatibility, please contact your lubricant supplier or manufacturer.

Grease Compatibility Chart

	Aluminum Complex	Barium Complex	Calcium Stearate	Calcium 12 Hydroxy	Calcium Complex	Calcium Sulfonate	Clay Non-soap	Lithium Stearate	Lithium 12 Hydroxy	Lithium Complex	Polyurea Conventional	Polyurea Shear Stable
Aluminum Complex		I	I	C	I	B	I	I	I	C	I	C
Barium Complex	I		I	C	I	C	I	I	I	I	I	B
Calcium Stearate	I	I		C	I	C	C	C	B	C	I	C
Calcium 12 Hydroxy	C	C	C		B	B	C	C	C	C	I	C
Calcium Complex	I	I	I	B		I	I	I	I	C	C	C
Calcium Sulfonate	B	C	C	B	I		I	B	B	C	I	C
Clay Non-soap	I	I	C	C	I	I		I	I	I	I	B
Lithium Stearate	I	I	C	C	I	B	I		C	C	I	C
Lithium 12 Hydroxy	I	I	B	C	I	B	I	C		C	I	C
Lithium Complex	C	I	C	C	C	C	I	C	C		I	C
Polyurea Conventional	I	I	I	I	C	I	I	I	I	I		C
Polyurea Shear Stable	C	B	C	C	C	C	B	C	C	C	C	

B = Borderline (test required) / **C** = Compatible / **I** = Incompatible

Dispensing Recommendations

Below are some general guidelines for bearing lubrication requirements. Requirements may vary with individual bearing types and operating conditions. Testing is recommended for specific applications. Please feel free to contact your local distributor should you need any assistance in setting proper dispensing rates.



E120
120cc

Bearing Shaft Diameter	120cc	Grease Volume
90mm (3.50") ~ 150mm (6.00")	1 month	4.00cc/day
65mm (2.50") ~ 89mm (3.50")	3 month	1.33cc/day
50mm (2.00") ~ 65mm (2.50")	6 month	0.67cc/day
45mm (1.75") ~ 50mm (2.00")	9 month	0.45cc/day
Under 45mm (1.75")	12 month	0.33cc/day



V125
125cc



M125
125cc



V250
250cc



M250
250cc



M500
500cc

Bearing Shaft Diameter	125cc	Grease Volume	250cc	Grease Volume	500cc	Grease Volume
230mm (9.00") ~ 330mm (13.00")					Half month	33.34cc/day
166mm (6.50") ~ 229mm (9.00")			Half month	16.67cc/day	1 month	16.67cc/day
102mm (4.00") ~ 165mm (6.50")	Half month	8.33cc/day	1 month	8.33cc/day	2 month	8.33cc/day
90mm (3.50") ~ 150mm (6.00")	1 month	4.17cc/day	2 month	4.17cc/day	4 month	4.17cc/day
77mm (3.00") ~ 89mm (3.50")	2 month	2.78cc/day	3 month	2.78cc/day	6 month	2.78cc/day
65mm (2.50") ~ 89mm (3.50")	3 month	1.39cc/day	6 month	1.39cc/day	12 month	1.39cc/day
50mm (2.00") ~ 65mm (2.50")	6 month	0.70cc/day	12 month	0.70cc/day	24 month	0.70cc/day
25mm (1.00") ~ 50mm (2.00")	12 month	0.35cc/day				

NOTE

- Grease volume (cc/day) may vary with ambient temperature changes, atmospheric pressure changes, consistency of grease, total length of lube line of remote installation, etc.
- Always pre-grease with a manual grease gun before the first installation. This ensures that the bearing has a clear passage. Pre-greasing should be conducted using either the same or at least compatible lubricant with what is contained in the Pulsarlube unit.
- Electrochemical products operates optimally at 20°C (68°F). Discharge rates may vary depending on temperatures variations from 20°C (68°F). Short term temperature variations from 20°C (68°F) will have little to no effect on the overall performance of electrochemical products.

Installation Options for Pulsarlube Products

Single Point and Remote Installation

Pulsarlube S, E and V series are designed to operate at relatively low pressures. Therefore, it is recommended mounting these units as close to the bearing as possible (figure 1 & 2).

As Pulsarlube electromechanical lubricators are designed to operate at high working pressures (30~60kgf/cm², 425~850psi), they can be remotely installed to lubricate multiple points (figure 3).

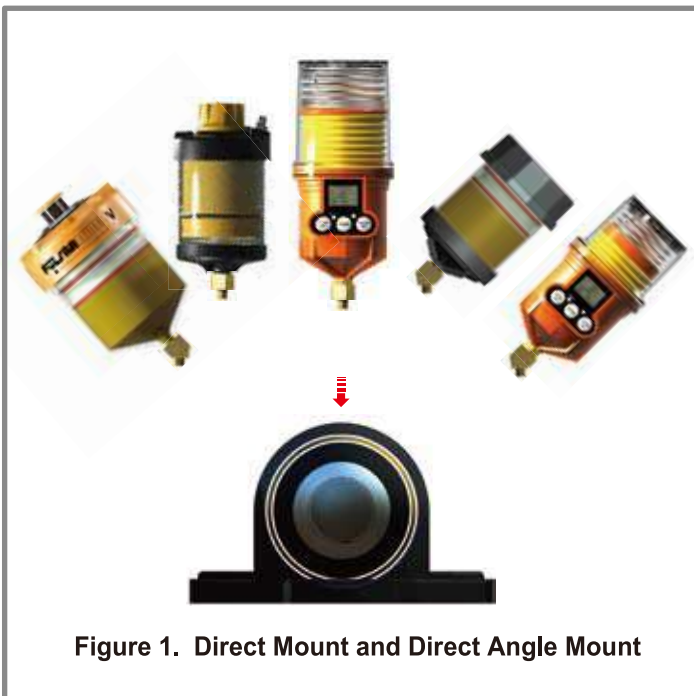

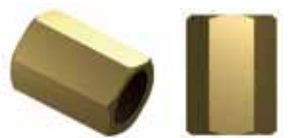





Figure 1. Direct Mount and Direct Angle Mount



Figure 2. Mounting with Extension Pipes & Remote Installation

Installation Parts				
 <p>Straight Reducer</p>	3/8"F	1/4"M	BSPT	
	3/8"F	1/8"M		
	1/4"F	1/4"M		
	1/4"F	1/8"M	BSPT/ NPT	
 <p>Socket Adaptor</p>	1/8"F	1/8"F	BSPT	
	1/4"F	1/4"F		
 <p>45° Reducer</p>	1/4"F	1/4"M	BSPT	
	1/8"F	1/8"M		
 <p>90° Elbow</p>	1/4"F	1/4"M	BSPT	
	1/8"F	1/8"M		
 <p>Extension Pipe</p>	1/8"M	1/8"M	50mm BSPT	
	1/8"M	1/8"M	100mm BSPT	
 <p>Push-in Fitting and Pre-filled Urethane Tubing</p>	Fits 5/16" tube	1/8"M	BSPT	

Multi Point Installation - Electromechanical Products ONLY

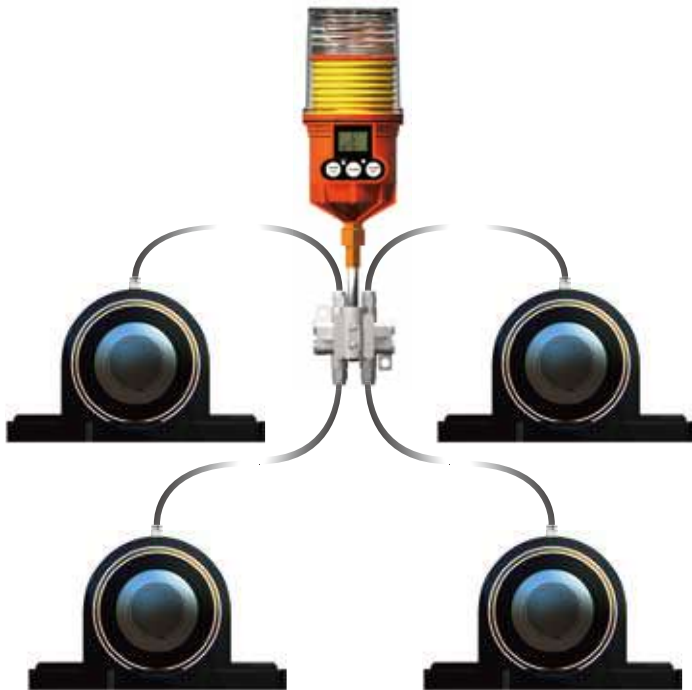
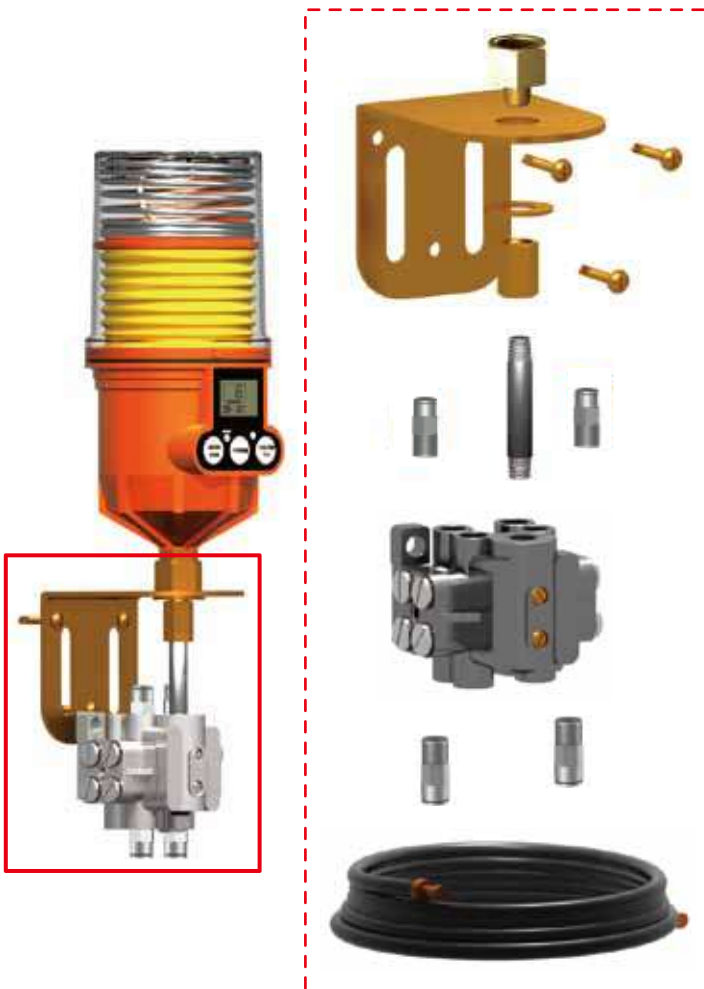

Figure 3. Multi Point Lubrication with Divider Block



Installation Parts for Multi Point Lubrication

Remote Mounting Kit				
Mounting Bracket Assembly		L-shape Mounting Bracket Steel Washer Self Drilling Screw		
Straight Reducer		3/8"F	1/4"M	BSPT
Straight Socket		1/4"F	1/4"F	
Extension Pipe		1/8"M	1/8"M	50mm BSPT
		1/8"M	1/8"M	100mm BSPT
Push-in Tube Fitting		Fits 6mm O.D. Tube	1/8"M	BSPT
Progressive Divider Block for Grease		U-4R	2, 3, 4 Ports	
		U-6R	5, 6 Ports	
		U-8R	7, 8 Ports	
Cross-porting Device		Horizontal Type	Combines two ports into one	
Distribution Tubing 6mm O.D. Tube		Empty	Available in 10ft. increments	
		Pre-filled		

Installation Options for Pulsarlube OL500

The Pulsarlube OL500 is a refillable oil lubricator, designed to lubricate up to 4 points. A typical example of an OL500 installation and a list of accessories are shown as below.

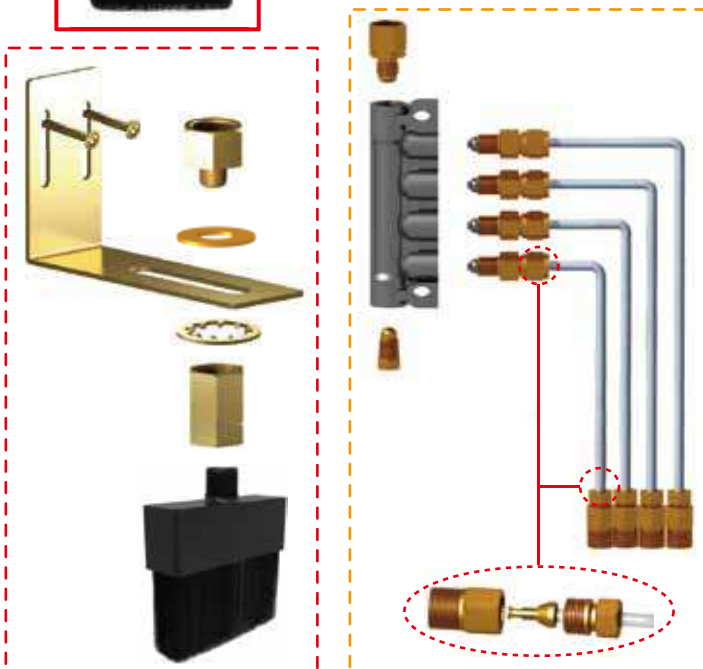

Installation Parts

Remote Mounting Kit				
Mounting Bracket Assembly		L-shape Mounting Bracket Steel Washer Self Drilling Screw		
Straight Reducer		3/8" F	1/8" M	BSPT
Reducer		1/8" F	M8	For oil distributor
Distributor		6(4P) M8		Up to 4 ports
Plug		M8		
Resistance Valve		M8 Connects distributor and tubing		
Distribution Tubing		4mm O.D. 2.5mm I.D. Nylon Tube		12m (30ft)
Fitting Connector		Ø4mm 1/8" M includes Ø4mm sleeve ring Ø4mm x Ø2.5mm insert		
Oil Brush Kit				
Brush Bracket Assembly		L-shape Mounting Bracket Steel Washer Self Drilling Screw		
Straight Reducer		3/8" F	1/8" M	BSPT
Brush Connector		1/8" F	1/8" F	BSPT/ NPT
1/8" F NPT Oil Brush	Plastic		Stainless Steel	

Shelf Life & Warranty

The shelf life of Pulsarlube products is 1 year from the date of manufacturing. Warranty period is valid for 1 year from the date of purchase. Product warranty is limited to original defects in material and workmanship.

